

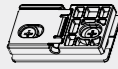

Glass Door Hanging Rollers Sliding Accessories

Accessories	Qty	Accessories	Qty	Accessories	Qty
	2		2		2
	1		1		2

Upper rail(single door)

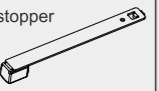
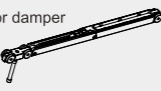
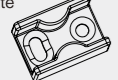

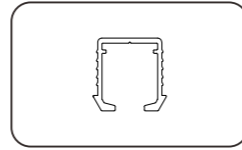
Upper rail(single door)

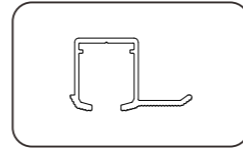

Upper rail(double door)

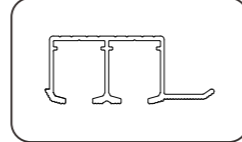

1. Cabinet size

Installation parameters: maximum door weight: 15kg,
minimum door width: 520mm, door thickness = 5mm.

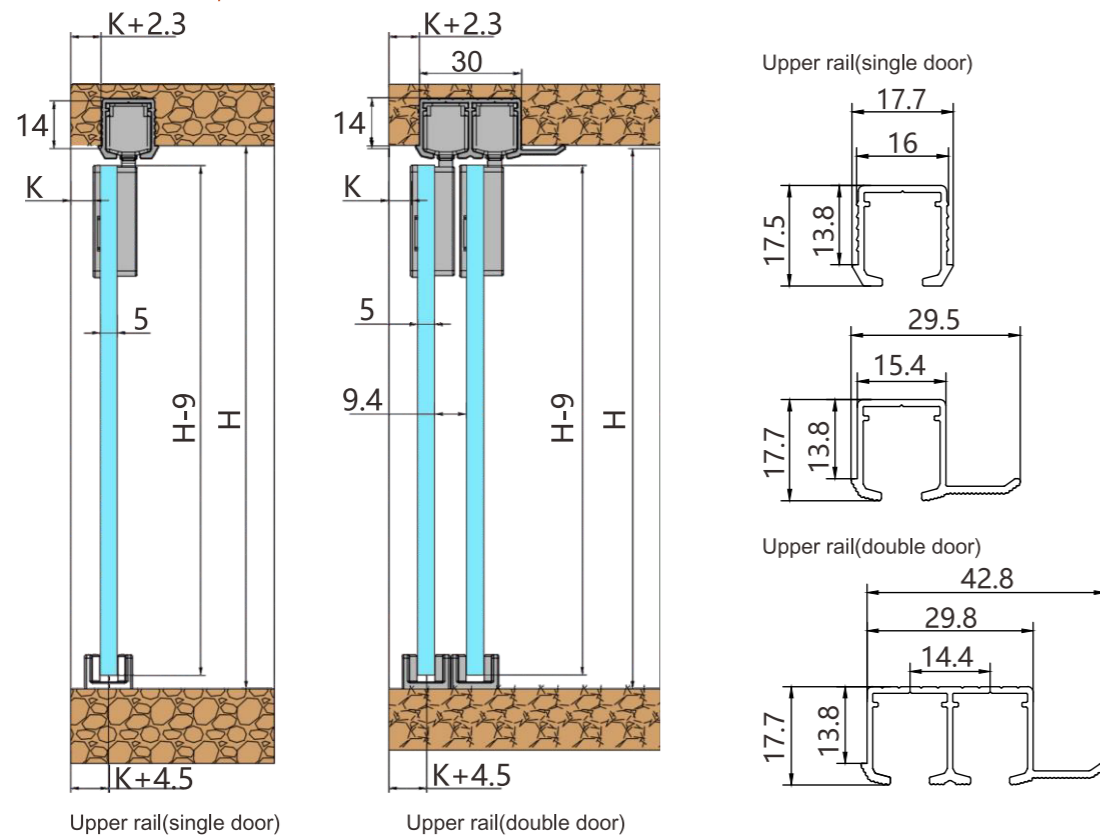

2. Drilling dimension

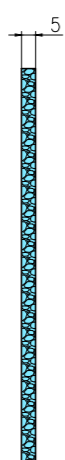
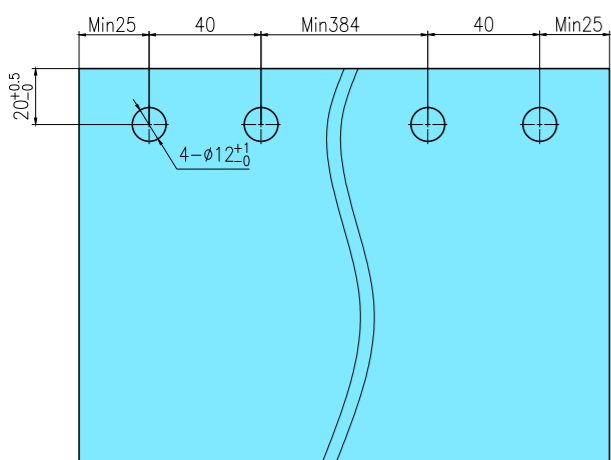

The minimum thickness of upper and lower board of single layer cabinet can be 18mm.

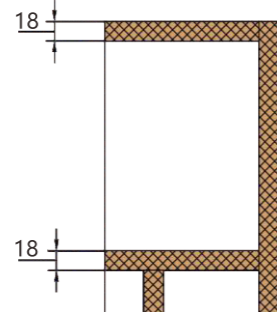

The thickness of the upper and lower layers of double layer cabinets can be 18mm, and the minimum thickness of the middle plate should be 25mm.

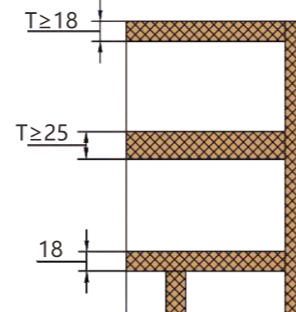

3. Install stopper and damper

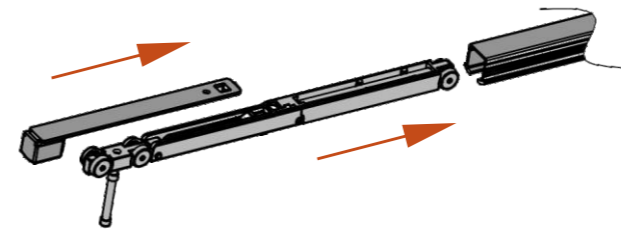

4. Install rail and positioning plate

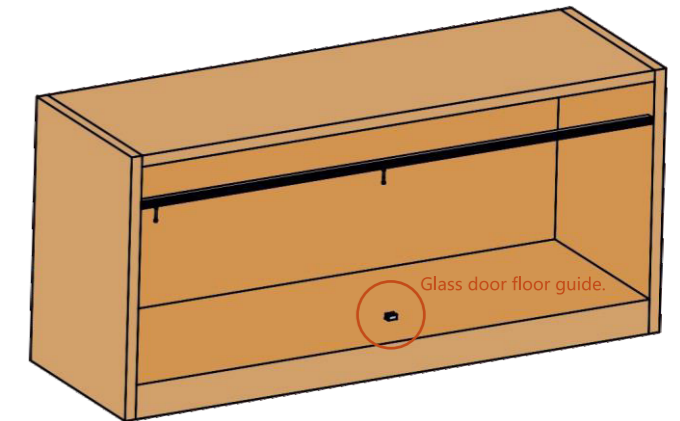

5. Drill holes on the door, install fixed block components and down rail

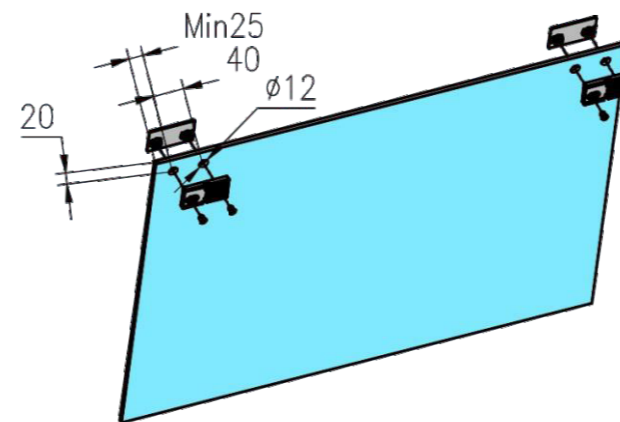

6. Install the door (hang the rod, lock the fastener)

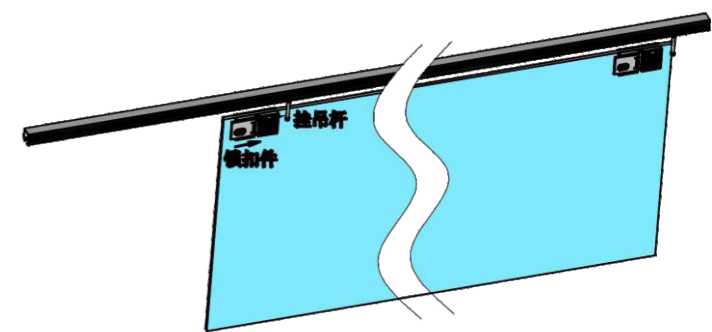

7. Adjust stopper to let the damper run completely and then close the door

