

Installation Manual

1. Appearance

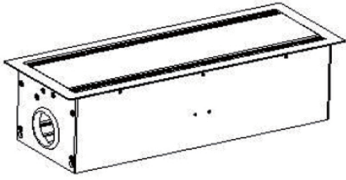

Fittings



x2



x2



x4

2. How to install

① Cut a hole

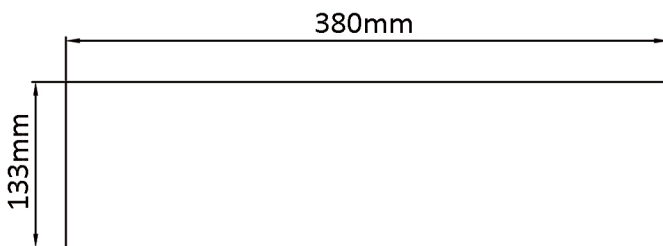

②

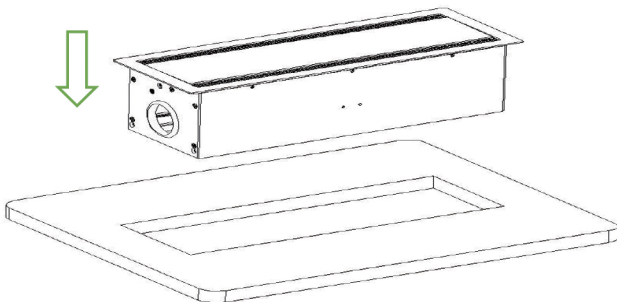

③

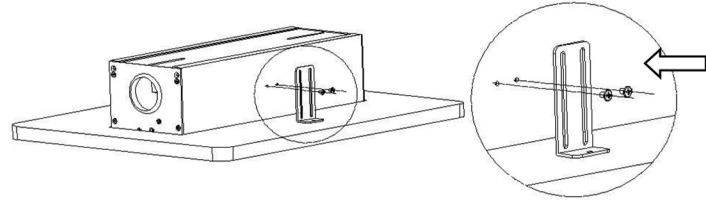

④

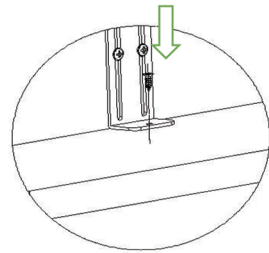
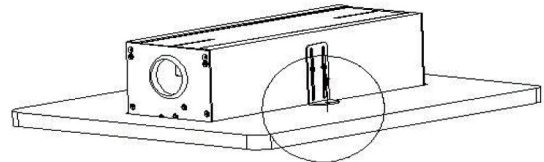

⑤

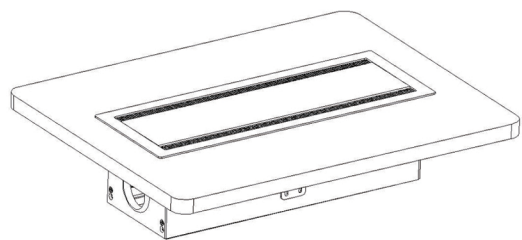

Cautions:

1. For indoors use only
2. Do not disassembly or poke it
3. Cut the power during installation
4. Keep away from heated or dusty surroundings
5. Cut the power if not use for a long time
6. No liquid ingress is allowed
7. Not allowed for use by children
8. Cut the power before cleaning
9. Stop using once abnormality if found
10. Installation should be done by professional electricians